



Fravizel

engineering



LOADING

PLEASE WAIT...



APRESENTAÇÃO

PRESENTATION
PRESENTACIÓN
PRÉSENTATION

facilitamos o seu trabalho

we make your work easier
hacemos su trabajo más fácil
nous facilitons son travail



85.000 m² área
8.000 m² área coberta
covered area
área cubierta
de la zone couverte

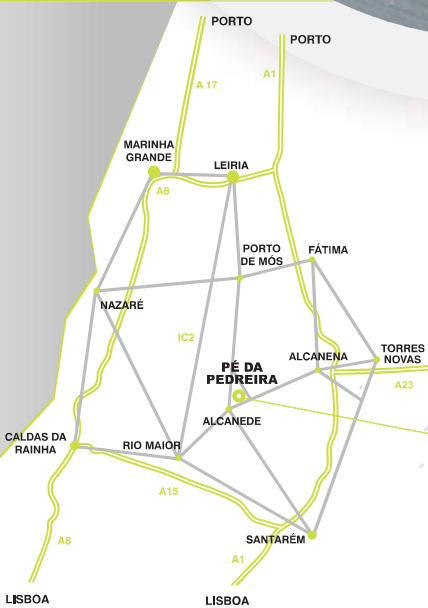

ZDE, APT 47
PÉ DA PEDREIRA
2025-999 ALCANEDE
PORTUGAL

+351 243 409 220
+351 243 409 221
geral@fravizel.com
sales@fravizel.com

GPS - 39°27'11.40N 8°50'32.00W





engenharia, engineering, ingeniería, ingénierie

inovação, innovation, innovación, innovation

qualidade, quality, calidad, qualité

sustentabilidade ambiental, environmental sustainability
sostenibilidad del medio ambiente, durabilité écologique

serviço pós-venda, after-sales service, servicio post-venta, service après-vente



rocha natural, natural stone, piedra natural, pierre naturelle



minas, mining, minería, mines



Construção e obra públicas, construction and public works,
construcción y obra públicas, construction et travaux public







florestal, forestry, florestal, forêt



portuário, port, portuario, portuaire



indústria, industry, industria, industrie

-  **acessórios para máquinas movimentação de terras**
attachments for earthmoving machinery, implementos para maquinaria de movimiento de tierra,
equipements pour machines de mouvement de terre
-  **rocha natural**
natural stone, piedra natural, pierre naturelle
-  **indústria**
industry, industria, industrie
-  **serviços**
services, servicios, services



**METAL
PORTUGAL**
SHAPING THE FUTURE



ACESSÓRIOS CARREGADORA

WHEEL LOADER ATTACHMENTS
IMPLEMENTOS PARA PALA CARGADORA
ÉQUIPEMENTS POUR CHARGEUSES



1
BALDE ROCHA (HDR)
ROCK BUCKET
CAZO PARA PIEDRA
GODET ROCHE



3
BALDE MINAS (MN)
MINING LOADER BUCKET
CAZO PARA GALERÍAS (INTERIOR)
MINES GODET



4
BALDE GRELHAS (GR)
SKELETON BUCKET
CAZO DE REJILLAS
GODET SQUELETTE





ACESSÓRIOS CARREGADORA
 WHEEL LOADER ATTACHMENTS
 IMPLEMENTOS PARA PALA CARGADORA
 ÉQUIPEMENTS POUR CHARGEUSES

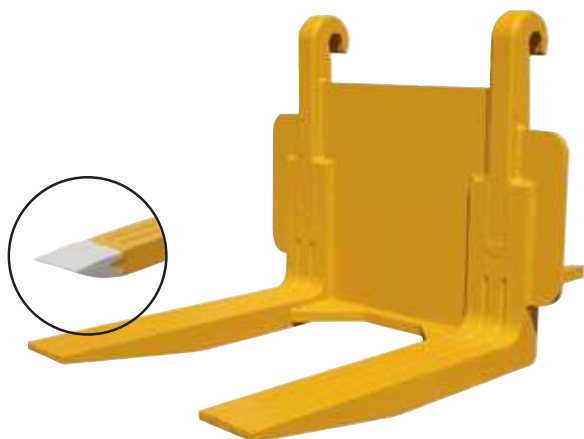

7₆
PATOLAS (PSP e PCP)
 FORKS
 HORQUILLAS
 KIT FOURCHES



7₆
PATOLAS VOLVO (PSP e PCP)
 VOLVO FORKS
 HORQUILLAS VOLVO
 KIT FOURCHES VOLVO



7₉₃
PATOLA RIPER
 BREAKER TINE
 HORQUILLA DE RIPPER
 FOURCHE THE RIPER



7₇
KIT PORTA PALETES (KPP)
 FORKS SET
 KIT PORTA PALETS
 KIT FOURCHES RÉGLABLES



ACESSÓRIOS CARREGADORA

WHEEL LOADER ATTACHMENTS
IMPLEMENTOS PARA PALA CARGADORA
ÉQUIPEMENTS POUR CHARGEUSES



7 10
ENGATE RÁPIDO HIDRÁULICO (ERH)
HYDRAULIC QUICK COUPLER
ENGANCHE RÁPIDO HIDRÁULICO
ATTACHE RAPIDE HYDRAULIQUE



7 92
ENGATE RÁPIDO HIDRÁULICO VOLVO (ERHV)
VOLVO HYDRAULIC QUICK COUPLER
ENGANCHE RÁPIDO HIDRÁULICO VOLVO
ATTACHE RAPIDE HYDRAULIQUE VOLVO



7 12
TRANSPORTADOR ENCAIXE EM 1 PATOLA 8t (T1P/8T)
FORK ADAPTER 8t
ÚTIL PARA UNA HORQUILLA CON GANCHO GIRATORIO 8t
TRANSPORTER 1 FOURCHE 16t



7 11
TRANSPORTADOR COM GANCHO ROTATIVO 6m com 8/16t (T6/16T)
6m ARM WITH HOOK 8/16t
ÚTIL ALARGADO 6m CON GANCHO GIRATORIO 8/16t
TRANSPORTER 6m 8/16t



7 9
TRANSPORTADOR ENCAIXE EM 2 PATOLAS 16t (T2P/16T)
2 FORKS ADAPTER WITH 16t
ÚTIL PARA 2 HORQUILLAS CON GANCHO GIRATORIO 16t
TRANSPORTER 2 FOURCHES 16t



7 94
TOMBA BANCADAS MECÂNICO
MECHANICAL STONE BENCH PUSHER
EMPUJADOR PARA BANCADAS DE PIEDRA MECANICO
MANIPULATION DE BLOCS



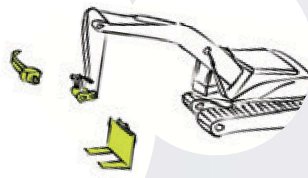

ACESSÓRIOS ESCAVADORA
EXCAVATOR ATTACHMENTS
IMPLEMENTOS PARA EXCAVADORAS
ÉQUIPEMENTS POUR PELLE HYDRAULIQUE



713
BALDE ROCHA (HDR)
ROCK BUCKET
CAZO PARA PIEDRA
GODET ROCHE



717
BALDE GRELHAS (GR)
SKELETON BUCKET
CAZO REJILLAS
GODET SQUELETTE



720
BALDE CRIVO (CV)
ROTARY SCREENING BUCKET
CAZO CRIBADOR
GODET SELECTIONNEUR ROTATIF



715
BALDE LIMPEZA (LPZ)
DITCH CLEANING BUCKET
CAZO LIMPEZA
GODET NETTOYAGE



721
BALDE OSCILANTE (LIMPEZA)
SWIVEL BUCKET (TILTING)
GODET CURAGE INCLINABLE
CAZO ORIENTABLE



795
LÂMINA DE LIMPEZA COM OSCILAÇÃO (LLO)
SCRAPER BLADE
BASE CON CUCHILLA DE LIMPEZA OSCILADO
LAME DE NETTOYAGE OSCILLÉ



ACESSÓRIOS ESCAVADORA

EXCAVATOR ATTACHMENTS

IMPLEMENTOS PARA EXCAVADORAS

ÉQUIPEMENTS POUR PELLE HYDRAULIQUE



14
BALDE PORTA BLOCOS (PB)
BLOCK LOADING BUCKET
CAZO Y CARGA BLOQUES
GODET PRISE DE BLOCS



16
BALDE EXTRA ROCHA (PXHDR)
BLOCKHANDLING EXTRA ROCK BUCKET
CAZO REFORZADO PARA PIEDRA
GODET PIERRE EXTRA ROCHE

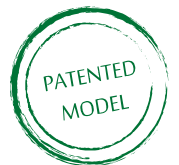

25
TOMBA BANCADAS (TB)
HYDRAULIC STONE BENCH PUSHER
EMPUJADOR PARA BANCADAS DE PIEDRA
RENVERSE DES BLOCS HYDRAULIQUE



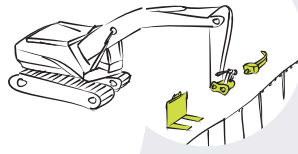

ACESSÓRIOS ESCAVADORA

EXCAVATOR ATTACHMENTS
IMPLEMENTOS PARA EXCAVADORAS
ÉQUIPEMENTS POUR PELLE HYDRAULIQUE



22
PATOLAS (PSP)
FORKS
HORQUILLAS
KIT FOURCHES



28
TRANSPORTADOR COM GANCHO 8/16T (T8)
TRANSPORTER WITH HOOK 8/16T
ÚTIL CON GANCHO ROTATIVO 8/16T
TRANSPORTER 8/16T AVEC CROCHET ROTATIF



23
RIPER SEM LUVA (R)
RIPPER WITHOUT TEETH
RIPPER SIN DIENTE
RIPPER DENTS MASSIVES



26
RIPER COM LUVA (RL)
RIPPER WITH TEETH
RIPPER CON DIENTE
RIPPER DENTS REMPLAÇABLES



29
BASE FERRAMENTAS
TOOLS BRACKET
SOPORTE DE HERRAMIENTAS
PLATINE POUR L'ÉQUIPEMENT



24
ENGATE RÁPIDO HIDRÁULICO COM MODIFICAÇÃO (ERHM)
HYDRAULIC QUICK COUPLER WITH MODIFICATION
ENGANCHE RÁPIDO HIDRÁULICO CON MODIFICACIÓN
ATTACHE RAPIDE HYDRAULIQUE AVEC MODIFICATION



27
ENGATE RÁPIDO HIDRÁULICO (ERH)
HYDRAULIC QUICK COUPLER
ENGANCHE RÁPIDO HIDRÁULICO
ATTACHE RAPIDE HYDRAULIQUE

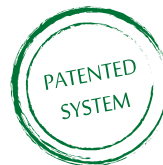

30
ENGATE RÁPIDO SIMPLEX (SIMPLEX)
QUICK COUPLER SIMPLEX
ENGANCHE RÁPIDO SIMPLEX
ATTACHE RAPIDE SIMPLEX

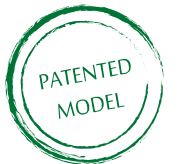

ACESSÓRIOS ESCAVADORA E DUMPER

DUMPER AND EXCAVATOR ATTACHMENTS
IMPLEMENTOS PARA EXCAVADORAS E CAMIONES
ÉQUIPEMENTS POUR PELLE HYDRAULIQUE E TOMBREAUX ARTICULES

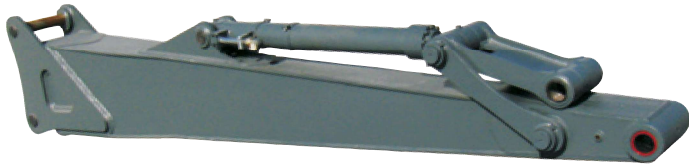

33
3ª LANÇA (3LÇ)
3rd ARM
3º BRAZO
3° FLÈCHE



40
TAIPAL (TP)
TAIL GATE
COMPUERTA TRASERA
HAYON



34
LANÇA POR MEDIDA (LÇ)
CUSTOM ARMS/BOOMS
BRAZOS POR MEDIDA
MONOBLOC ET BALANCIER



41
PLATAFORMA TRANSPORTE DE BLOCOS (PTB)
BLOCK TRANSPORT PLATFORM
PLATAFORMA PARA TRANSPORTAR BLOQUES
PLATE-FORME DE TRANSPORT DE BLOCS



38
CAIXA DE CARGA (CC)
BOX
CAJA DE CARGA
BOÎTE





ROCHA NATURAL

NATURAL STONE
PIEDRA NATURAL
PIERRE NATURELLE



➤ **PLATAFORMA CARREGAMENTO E TRANSPORTE**
TRANSPORT PLATFORM
PLATAFORMA DE CARGA Y TRANSPORTE
PLATE-FORME DE CHARGEMENT

➤ **44 MÁQUINA PERFURAÇÃO COM RASTOS (MPL)**
TRACKED DRILLING MACHINE
PERFORADORA MÓVIL POR CADENA DE GOMA
MACHINE DE PERFORATION AVEC CHARRIOT HYDRAULIQUE



➤ **96 MÁQUINA PERFURAÇÃO FIXA C/DESLOCAMENTO 2/3 MARTELOS (MPFD)**
RIG DRILLING MACHINE WITH DISPLACEMENT 2/3 HAMMERS
PERFORADORA FIJA COM DESPLAZAMIENTO 2/3 MARTILLOS
MACHINE DE PERFORATION FIXÉ AVEC DÉPLACEMENT 2/3 MARTEAUX



➤ **45 MÁQUINA PERFURAÇÃO FIXA 1/2/3 MARTELOS (MPF)**
RIG DRILLING MACHINE 1/2/3 HAMMERS
PERFORADORA FIJA 1/2/3 MARTILLOS
MACHINE DE PERFORATION FIXÉ 1/2/3 MARTEAUX



ROCHA NATURAL

NATURAL STONE
PIEDRA NATURAL
PIERRE NATURELLE

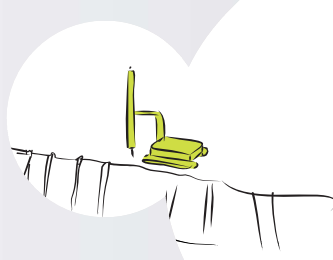

746

MÁQUINA FUNDO FURO COM RASTOS (MFFR) ELÉTRICA/DIESEL
TRACKED (DTH) DRILLING MACHINE ELECTRIC/DIESEL
MAQUINA DE PERFORAR FONDO MÓVIL POR CADENA DE GOMA ELECTRIC/DIESEL
MACHINE FOND TROU AVEC CHARRIOT HYDRAULIQUE ELECTRIC/DIESEL



747

MÁQUINA FUNDO FURO DE CANTO (MFFPC)
CORNER (DTH) DRILLING MACHINE
MAQUINA DE PERFORAR FONDO DE CANTO
MACHINE FOND TROU DE CHANT



748

MÁQUINA FUNDO FURO COLUNA (MFFC)
COLUMN (DTH) DRILLING MACHINE
MAQUINA DE PERFORAR FONDO DE COLUMNA
MACHINE FOND TROU COLONNE



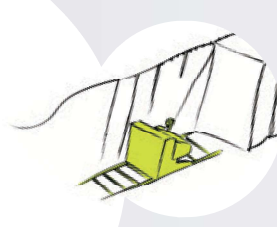

ROCHA NATURAL

NATURAL STONE
PIEDRA NATURAL
PIERRE NATURELLE



51
MÁQUINA DE FIO DE CABEÇA ROTATIVA 60/75/100 CV (MFCR)
HEAD ROTATION DIAMOND WIRE MACHINE 60/75/100 HP
MAQUINA DE CORTE POR HILO DIAMANTADO DE CABEÇA ROTATIVA 60/75/100 HP
SCIE FIL AU DIAMANT AVEC TÊTE ROTATIVE 60/75/100 HP

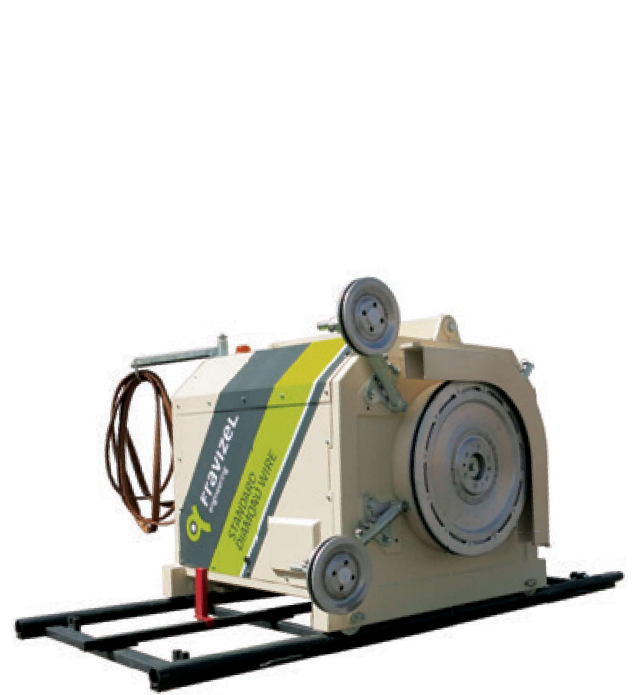

49
MÁQUINA DE FIO STANDARD 40/50/60 CV (MFS)
STANDARD DIAMOND WIRE MACHINE 40/50/60 HP
MAQUINA DE CORTE POR HILO DIAMANTADO ESTÁNDAR 40/50/60 HP
SCIE FIL AU DIAMANT STANDARD 40/50/60 HP



CARRIL
TRACK
CARRIL
RAIL



53
MÁQUINA DE FIO TRIANGULAR 50/60/75 CV (MFT)
TRIANGULAR DIAMOND WIRE MACHINE 50/60/75 HP
MAQUINA DE CORTE POR HILO DIAMANTADO TRIANGULAR 50/60/75 HP
SCIE FIL AU DIAMANT TRIANGULAIRE 50/60/75 HP



ROCHA NATURAL

NATURAL STONE
PIEDRA NATURAL
PIERRE NATURELLE

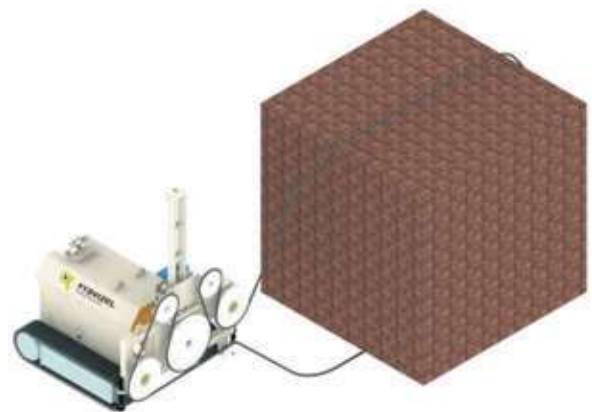
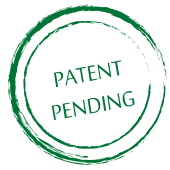
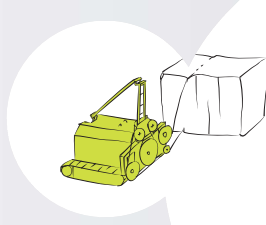

50

MÁQUINA DE FIO COM RASTOS 25-75 CV (MFR)

TRACKED DIAMOND WIRE MACHINE 25-75 HP

MAQUINA DE CORTE POR HILO DIAMANTADO MÓVIL POR CADENA DE GOMA 25-75 HP

SCIE FIL AU DIAMANT AVEC CHARRIOT HYDRAULIQUE 25-75 HP



97

MÁQUINA DE FIO DE RASTOS COM CARRIL 25-100 CV (MFRC)

TRACKED DIAMOND WIRE MACHINE WITH TRACK 25-100 HP

MAQUINA DE CORTE POR HILO DIAMANTADO MÓVIL POR CADENA DE GOMA 25-100 HP

SCIE FIL AU DIAMANT AVEC CHARRIOT HYDRAULIQUE ET RAIL 25-100 HP



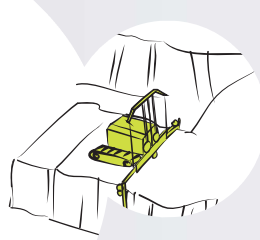

ROCHA NATURAL

NATURAL STONE
PIEDRA NATURAL
PIERRE NATURELLE

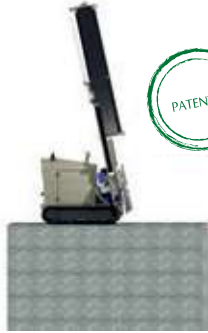

PATENTED



PATENTED
MODEL



52

MÁQUINA DE FIO EXTENSÍVEL COM RASTOS 40 CV (MFER)

EXTENSIBLE TRACKED DIAMOND WIRE MACHINE 40 HP

MAQUINA DE CORTE POR HILO DIAMANTADO MÓVIL POR CADENA DE GOMA EXTENSIBLE 40 HP

SCIE FIL AU DIAMANT EXTENSIBLE AVEC CHARRIOT HYDRAULIQUE 40 HP



ROCHA NATURAL

NATURAL STONE
PIEDRA NATURAL
PIERRE NATURELLE

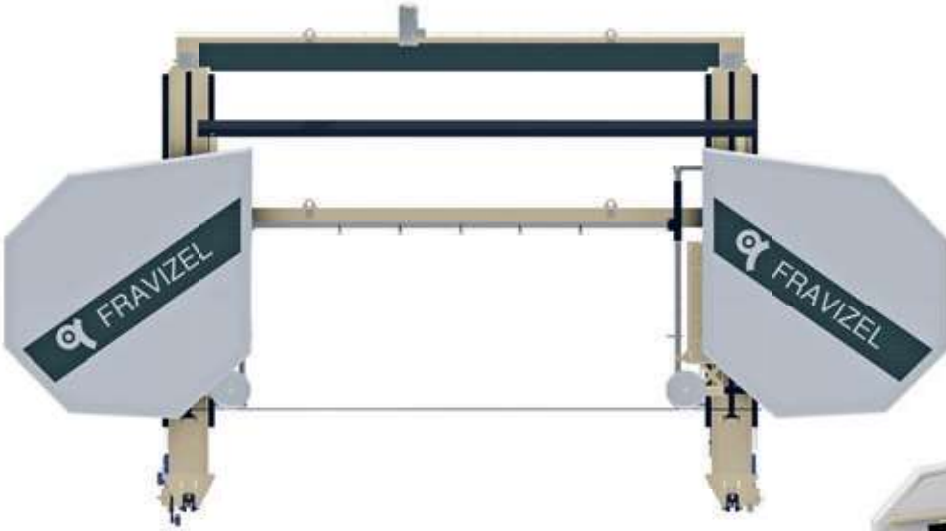
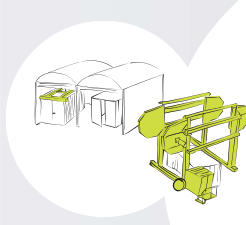

➤ 99
MONOFIO ROLLER (MONO)
MONOWIRE ROLLER
MONOHILLO ROLLER
MONOFIL ROLLER

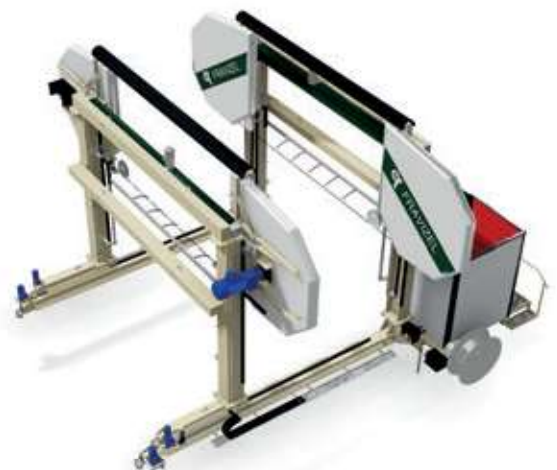
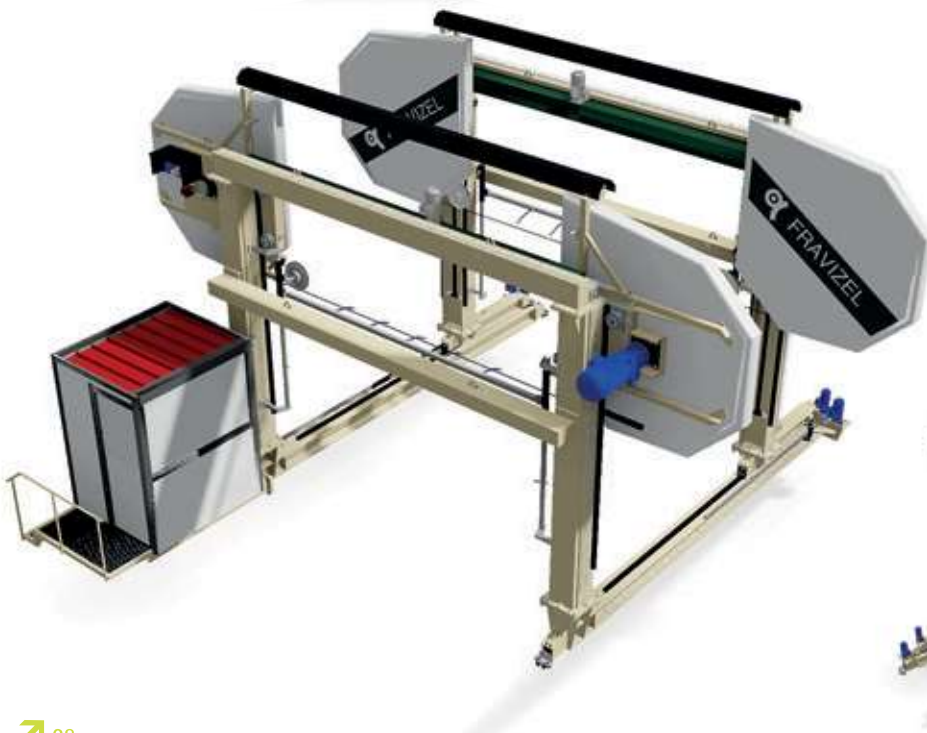

➤ 98
TWIX ROLLER (TWIX)
TWIX ROLLER
TWIX ROLLER
TWIX ROLLER





ROCHA NATURAL

NATURAL STONE
PIEDRA NATURAL
PIERRE NATURELLE



➤ 58
PRENSA HIDRÁULICA DE PEDRA 25 A 150t (PHP)
STONE SPLITTING MACHINE 25 TO 150t
CIZALLA HIDRÁULICA PARA PIEDRA DE 25 A 150t
PRESS HYDRAULIQUE À PIERRE 25 A 150t



➤ 60
CAIXA DE CALÇADA (CXC)
BOX (1M³ BOX WITH UPPER ATTACHMENT)
CESTÓN PARA ADOQUINES
BOÎTE À PIERRE



➤ 55
PRENSA HIDRÁULICA DE PEDRA TÚNEL 120 A 600T (PPT e PPTX)
STONE SPLITTING MACHINE (TUNNEL TYPE) 120 TO 600T
CIZALLA HIDRÁULICA PARA PIEDRA TÚNEL DE 120 A 600T
PRESS HYDRAULIQUE À PIERRE 120 À 600T



➤ 55
PRENSA HIDRÁULICA DE PEDRA TÚNEL 120 A 600T (PPT e PPTX)
STONE SPLITTING MACHINE (TUNNEL TYPE) 120 TO 600T
CIZALLA HIDRÁULICA PARA PIEDRA TÚNEL DE 120 A 600T
PRESS HYDRAULIQUE À PIERRE 120 À 600T



ROCHA NATURAL

NATURAL STONE
PIEDRA NATURAL
PIERRE NATURELLE

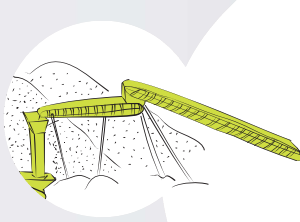

57

TRANSPORTADOR EM TELA (TET)
RUBBER CONVEYOR
CINTA TRANSPORTADORA EN GOMA
CONVOYEUR EN CAOUTCHOUC



59

TRANSPORTADOR EM TELHAS (2T)
STEEL CONVEYOR
CINTA TRANSPORTADORA METÁLICA
CONVOYEUR DE FER



56

TRANSPORTADOR EM TELHAS COM TREMONHA (3T)
STEEL CONVEYOR WITH FEED HOPPER
CINTA TRANSPORTADORA METÁLICA Y TOLVA
CONVOYEUR DE FER AVEC TRÉMIE





ROCHA NATURAL

NATURAL STONE
PIEDRA NATURAL
PIERRE NATURELLE



62
MOINHO DE MARTELOS (MM)
IMPACT CRUSHER
MOLINO DE MARTILLOS
MOLIN DE MARTEAUX



61
MÁQUINA LIMPEZA E ENVELHECIMENTO DE CUBOS (MLEC)
SURFACE AGEING/ TUMBLING/ POLISHING AND WASHING STONE MACHINE
MAQUINA DE LIMPIEZA Y ENVEJECIDO PARA ADOQUÍN
MACHINE DE NETTOYAGE ET LE VIEILLISSEMENT CUBES



63
MÁQUINA DE SEIXO ROLADO (MSR)
ROCK TUMBLER MACHINE
MAQUINA DE CANTO RODADO
MACHINE DE GALETS



ROCHA NATURAL

NATURAL STONE
 PIEDRA NATURAL
 PIERRE NATURELLE

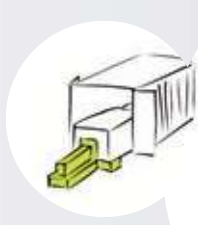

64
VIRA BLOCOS (VB) 30/35/45t
 MACHINE TO TURN BLOCKS 30/35/45t
 VOLTEADOR DE BLOQUES 30/35/45t
 MACHINE À RETOURNER LES BLOCS 30/35/45t



67
VIRA CHAPAS (VC) 5/10t
 MACHINE TO TURN SLABS 5/10t
 VOLTEADOR DE TABLAS 5/10t
 MACHINE À RETOURNER LES PLAQUES 5/10t

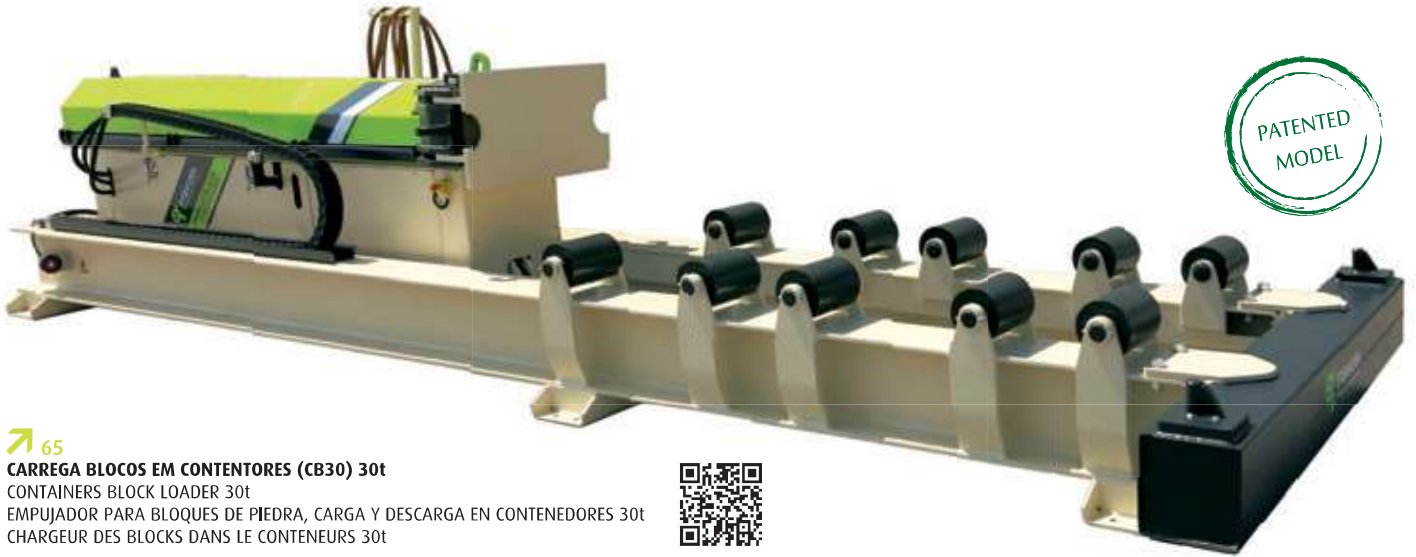

65
CARREGA BLOCOS EM CONTENTORES (CB30) 30t
 CONTAINERS BLOCK LOADER 30t
 EMPUJADOR PARA BLOQUES DE PIEDRA, CARGA Y DESCARGA EN CONTENEDORES 30t
 CHARGEUR DES BLOCS DANS LE CONTENEURS 30t

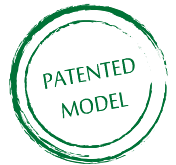

CARREGA CHAPAS EM CONTENTORES (CC4) 4t
 CONTAINERS SLAB LOADER 4t
 CARGADOR DE TABLAS EN CONTENEDORES 4t
 CHARGEUR DES PLAQUES DANS LE CONTENEURS 4t





ROCHA NATURAL

NATURAL STONE
PIEDRA NATURAL
PIERRE NATURELLE



↗ 68
CAVALETE 2400 COM ENCOSTO CENTRAL (CV24)
RACK 2400 WITH CENTRAL SUPPORT
CABALLETE 2400 CON APOYO CENTRAL (GIGANTE)
CHEVALET 2400 AVEC APPUI CENTRAL



↗ 71
CAVALETE COM ENCOSTO PARA CAMIÃO (CVEC)
RACK WITH SUPPORT FOR ROAD TRANSPORT
CABALLETE CON APOYO PARA TRANSPORTE EN CAMIÓN
CHEVALET AVEC APPUI POUR CAMION



↗ 69
CAVALETE PARQUE (CVP)
BUNDLE PARK
CABALLETE ESTÁTICO PARA STOCKAGE
CHEVALET PARC



↗ 100
CAIXA RESÍDUOS HIDRÁULICA COM ABERTURA CENTRAL (CRH)
CLAMSHELL RESIDUES BOX
CESTÓN HIDRÁULICO PARA RESIDUOS CON APERTURA CENTRAL
BOÎTE HYDRAULIQUE POUR RÉSIDUS AVEC OUVERTURE CENTRALE



↗ 70
REBOQUE DE TRANSPORTE (RT)
FORKLIFT TRAILER
REMOLQUE PARA TRANSPORTE
REMORQUE DE TRANSPORT



↗ 73
MESA DE CORTE (MC)
STONE CUTTING TABLE
MESA DE CORTE Y APILABLE
TABLE DE DÉCOUPE



↗ 72
PALETE EMPILHÁVEL (PE)
STACKABLE PALLET
PALET APILABLE PARA STOCKAGE
PORTE PALETTE À EMPILAGE



INDÚSTRIA

INDUSTRY
INDUSTRIA
INDUSTRIE

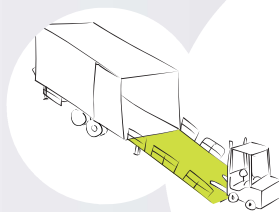

74

PORTA SILOS (PS)

SILO TRANSPORT AND PLACING UNIT
PORTA SILOS PARA TRANSPORTE
TRANSPORT ET PLACEMENT DE SILO



77

CAIS MÓVEL (CM)

MOBILE PLATFORM/LOADING PLATFORM
RAMPA DE CARGA O DESCARGA MÓVIL
PLATE-FORME DE CHARGEMENT



75

MOVIMENTADOR DE CONTENTORES DE CABOS 32t (PCC6)

CONTAINER GRAB OF CABLE 32t
ÚTIL POR ESLINGAS PARA MOVIMENTO DE CONTENEDORES
TRANSPORTEUR POUR CONTENEUR DE CÂBLES 32t



78

RAMPA DE ACESSO A CONTENTOR (RC)

CONTAINER ACCESS RAMP
RAMPA DE ACESSO A CONTENEDOR
PASSARELLE D'ACCÈS AUX CONTENEURS



79

MOVIMENTADOR DE CONTENTORES DE CHASSI 32t (PC6M)

CONTAINER GRAB OF UPPER CHASSI 32t
ÚTIL RÍGIDO PARA MOVIMENTO DE CONTENEDORES
TRANSPORTEUR POUR CONTENEUR DE FRAME 32t



80

CAIXA RESÍDUOS (C)

RESIDUES BOX/TIPPER BOX
CESTÓN PARA RESÍDUOS
BOÎTE POUR RÉSIDUS SOLIDES



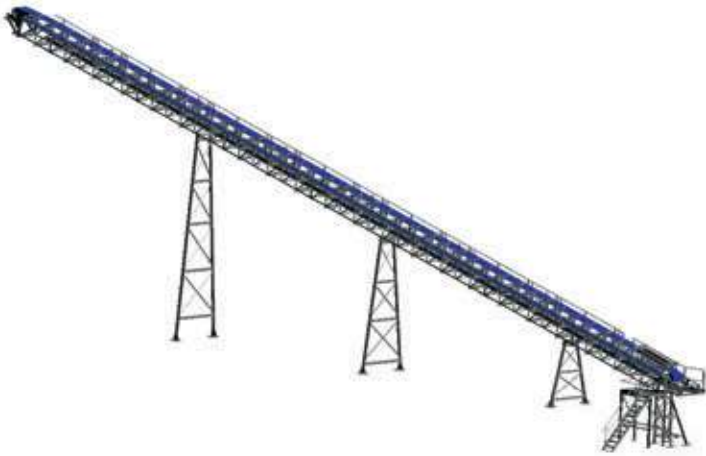
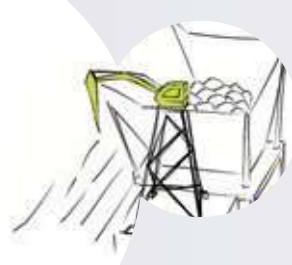

102
TELA TRANSPORTADORA (TT)
CONVEYOR
CINTA TRANSPORTADORA
TRANSPORTEUR



101
TELA TRANSPORTADORA MÓVEL (TTM)
MOBILE CONVEYOR
CINTA TRANSPORTADORA MÓVIL
TRANSPORTEUR MOBILE



76
TELA TRANSPORTADORA DE RASTOS (TTR)
TRACKED CONVEYOR
CINTA TRANSPORTADORA MÓVIL DE ORUGA
TRANSPORTEUR MOBILE



81
BRAÇO HIDRÁULICO (BH)
HYDRAULIC BOOM
BRAZO HIDRÁULICO
BRÁS HIDRAULIQUE



30 years
making history

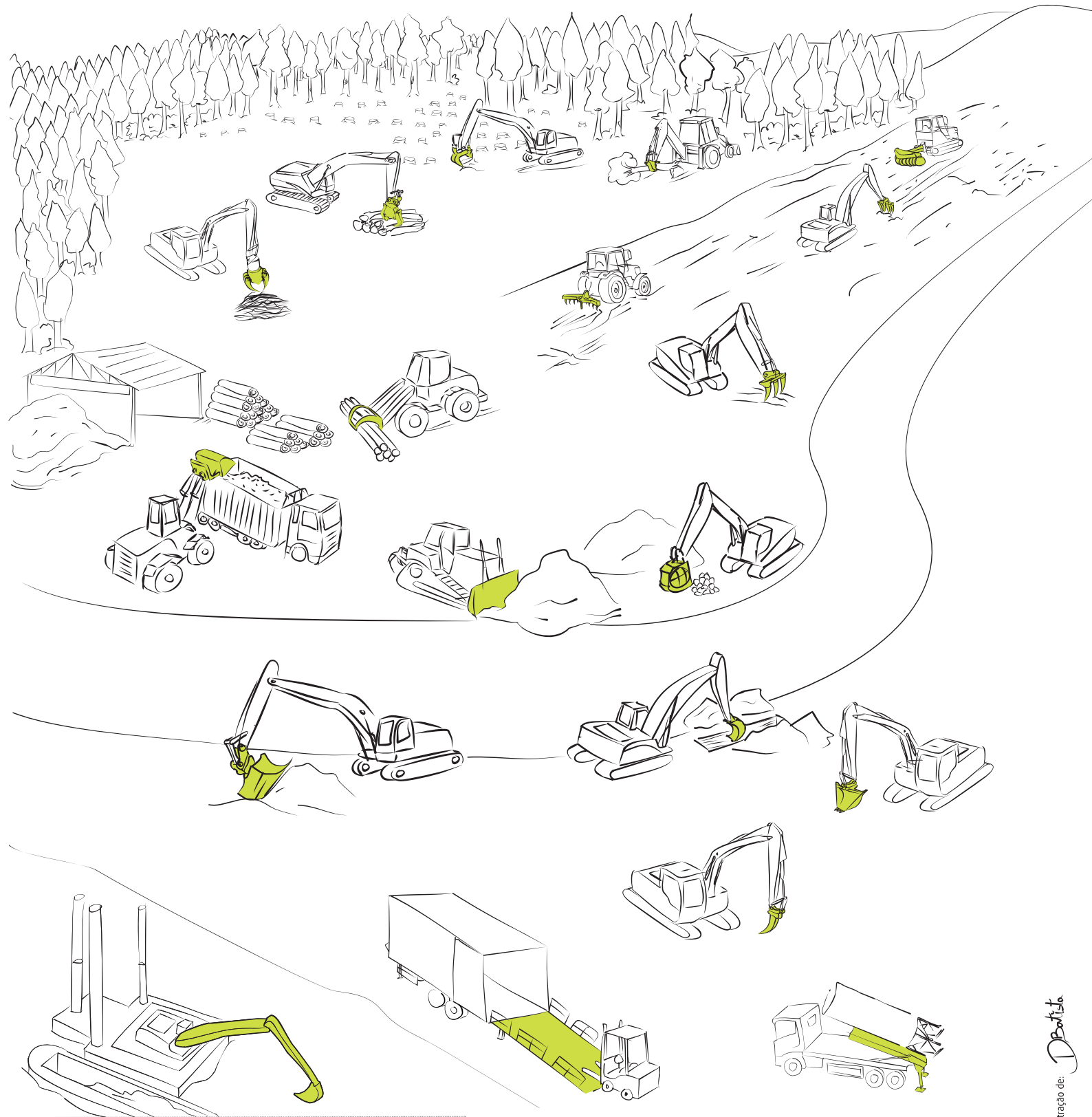

Agent



www.fravizel.com

ISO 9001
BUREAU VERITAS
Certification



ISO 14001
BUREAU VERITAS
Certification



Papel Proveniente
de Fontes Responsáveis

Versão RN03/2018

Ilustração de: *D. Batista*